

Varenummer: 2311011382
Beskrivelse: E+G Vertikal søjleoliestandsglas
HCZ.76

Mål

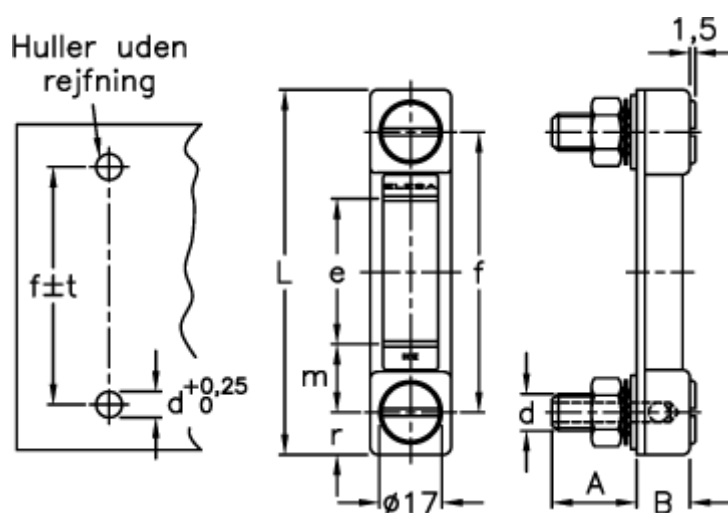

A = 23	Max. tilspændingsmoment (Nm) = 12 til 15
B = 14.5	r = 11.5
C = 22	t = +/-0,5
d = M10	
e = 40	
f = 76	
L = 99	
m = 18	